

Foot-switch Series F1 UN

Description **F1-AI4-20mA UN**

Article number **6161000730**

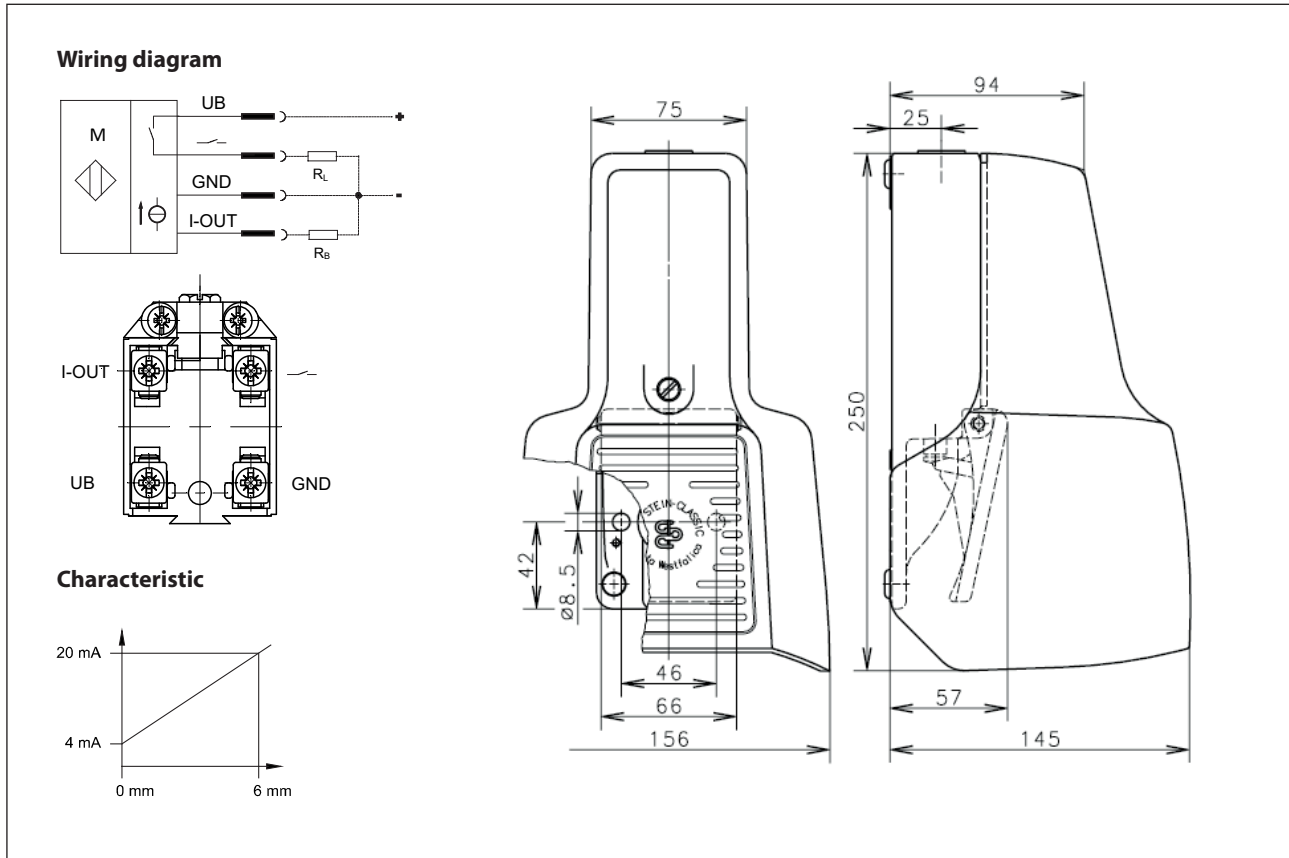

Electrical data

Rated operational voltage	U_e	12-26 V DC
Utilization category		DC-13 U_B 12-26 DC / 0,2 A acc. to IEC/EN 60947-5-2
Current output		4-20 mA
Short-circuit protection type switching element		permanently short-circuit and overload protected, clocking
Protection class		III (safety extra-low voltage)

Mechanical data	
Enclosure	AL, die-cast
Protective guard (Accident protection cover UN)	AL, die-cast
Actuator	Foot lever (PA)
Ambient air temperature	-30° C ... +80° C
Contact type	PNP N.O., teachbar 0,1-5,9 mm
Operating force	≈ 10 N (pedal centre)
Mechanical life	10 x 10 ⁶ operating cycles
Switching frequency	max. 50 / min
Assembly	2 x M8
Connection	screw terminals (M3,5)
Number of connections	8
Conductor cross-sections	Solid: 0,5 ... 1,5 mm ² or Litz wire with ferrules: 0,5 ... 1,5 mm ²
Cable entrance	1 x M20 x 1,5
Weight	≈ 1,5 kg
Protection type	IP65 acc. to IEC/EN 60529

Standards
EN 60947-5-7

EU Conformity ¹⁾
acc. to directive 2014/30/EU (EMC-Directive)

Notes
The degree of protection specified (IP code) applies only to a properly closed cover and the use of an equivalent cable gland with adequate cable.
¹⁾ To be conform with the EMV guideline (2014/30/EU) a shielded connection cable has to be used.